

DT8018A3 Tunnel Diode Detector

8.0 to 18.0 GHz Negative Polarity, SMA Connector, Bias Detector with 50Ω SMA Male to SMA Female
 Female Video Out Operating from 8.0 to 18.0 GHz



"A3" pkg. P/N DT8018A3



Product Export Classification
 ECCN: EAR 99 (Unless otherwise specified)
 HTS: 8542330000

CONFIGURATION	
Bias Type	No Bias
Detector Polarity, Note 3	Negative [-]
Body Style	Coaxial
RF Input Connector	SMA [Male]
RF Input Impedance	50 Ω
Video Output Connector	SMA [Female]
Detector Type	Broadband

NOTES:

1. TSS is measured with a video amplifier having at least 50dB gain, <3dB NF and 2 MHz video bandwidth.
2. Typical values are measured at +25°C and are not guaranteed.
3. Negative output polarity is standard. Add P to the end of the model number for positive polarity, ex. DT8018PA3 Pos(+)
4. To select a package, refer to pg. 2 and insert package name, ex. NB. Order P/N D8018NB (polarity + or -)

A3 Outline Drawing

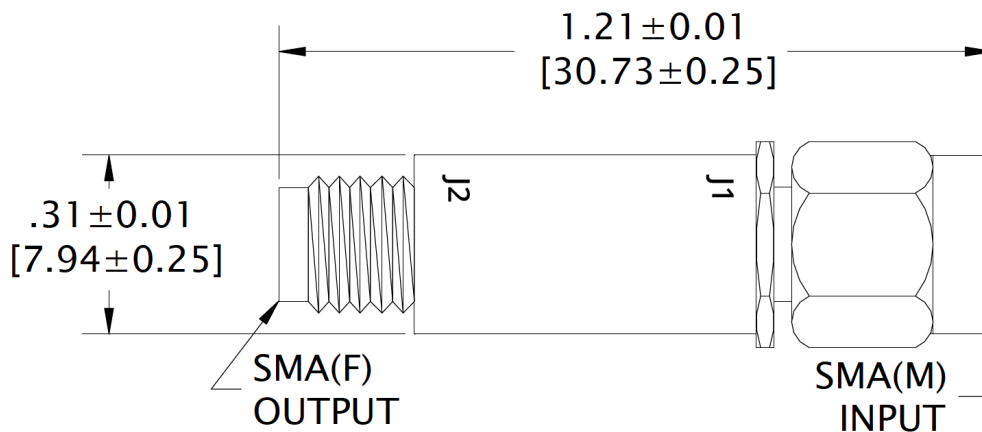

About EclipseMDI

ECLIPSE Microdevices is located in San Jose, California. ECLIPSE has been developing high performance analog semiconductors for use in wireless radio frequency (RF), microwave, and millimeter wave for commercial and industrial applications. ECLIPSE has formed a strategic alliances - with foundries that features leading state-of-the-art process technologies and with manufacturing facilities for high-volume production of innovative RFIC's.

PRODUCT FEATURES
No bias required
Extremely low video output resistance (125 Ω typ)
Extremely fast pulse response (5 nsec risetime typ)
Excellent frequency response
Excellent dynamic range & loaded voltage output sensitivity
Negative Polarity is Standard
High Reliability Hermetically Sealed Coax
RoHS Compliant

ELECTRICAL SPECIFICATIONS	
Frequency Range [GHz]	8.0 to 18.0
Voltage Sensitivity [mV/mW], typ.	700
Tss [dB], Note 1, typ.	-47
VSWR, typ.	3.0:1
Flatness [±dB], typ.	0.75
Video Cap [pF], typ.	10

MAXIMUM RATINGS	
Max. Input Power [dBm]	13
Storage Temperature [deg. °]	-65° to +125 ° C
Operating Temperature [deg. °]	-65° to +115 ° C
Specifications @ [° C]	25



DT8018A3 Tunnel Diode Detector

8.0 to 18.0 GHz Negative Polarity, SMA Connector, Bias Detector with 50Ω SMA Male to SMA Female
Female Video Out Operating from 8.0 to 18.0 GHz



Outline Drawings

NB

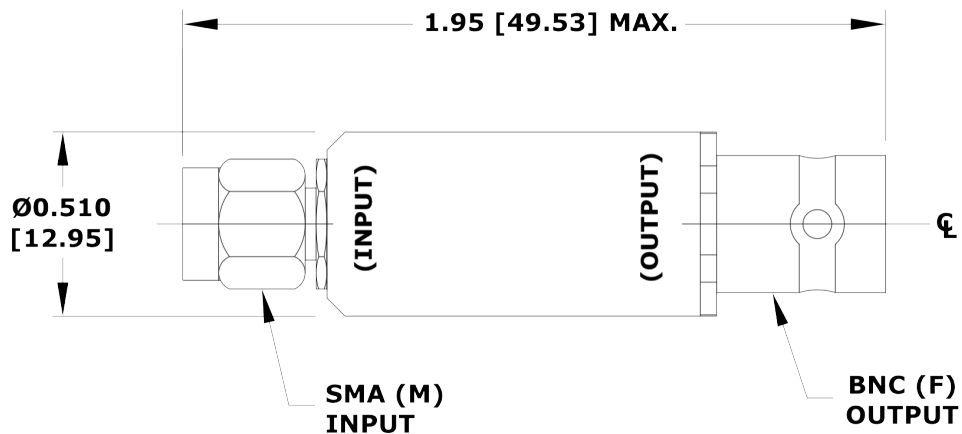

NC

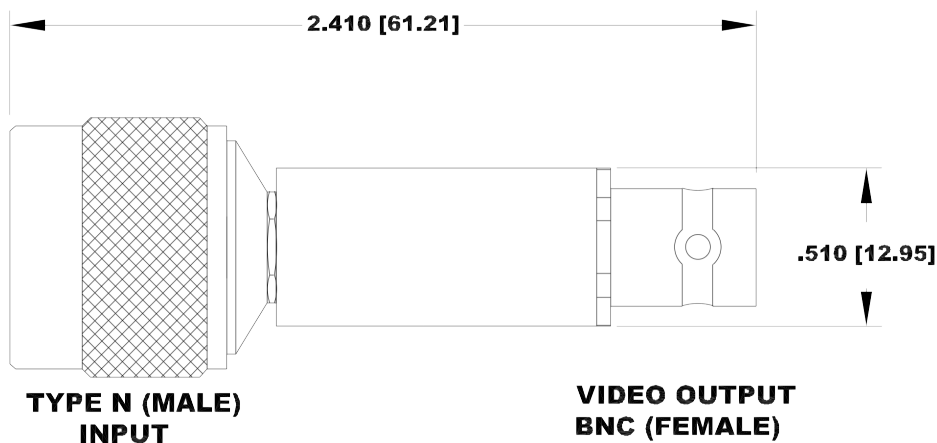

N

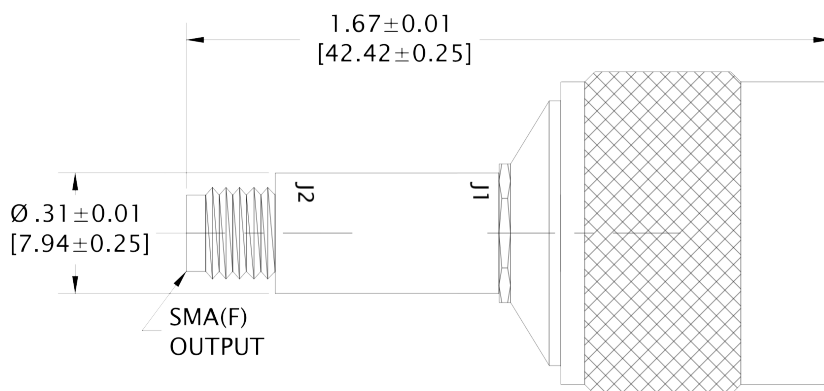

TYPE "N" MALE - INPUT CONNECTOR